

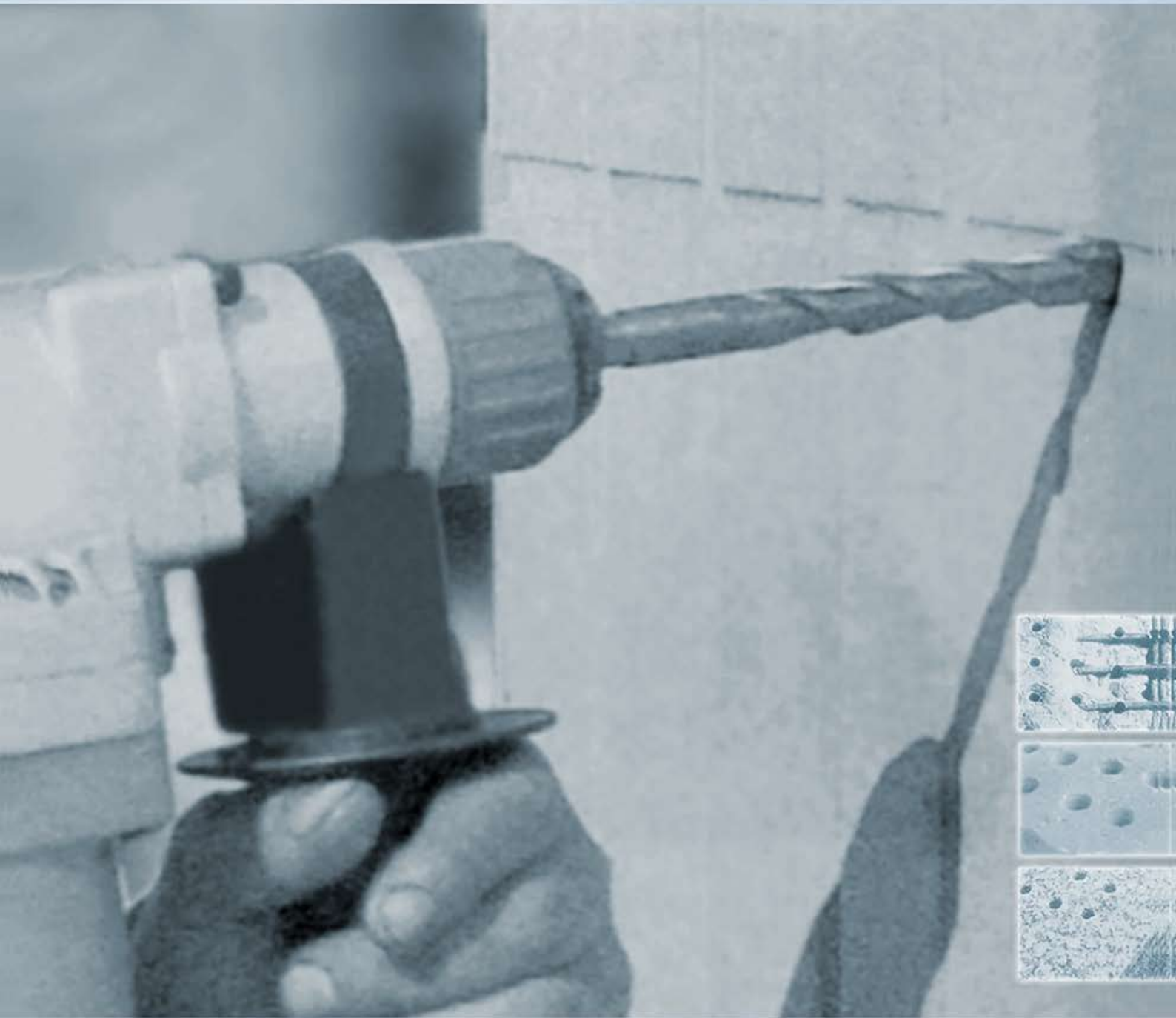















MASONRY DRILL



DETAILED INFORMATION FOR MASONRY DRILL

DRILLING TOOLS

DRILLING TOOLS

Technics	Picture	Description	Standard
Roll Forged		Zinc plated	DIN8039
		Black Oxide	
		Nickel plated	
		Black & white finished	
		sandblasted	
Milled		High-helix Zinc plated	DIN8039
		High-helix Nickel plated	
		High-helix Chrome plated	
		Parabola flute	
Milled		sandblasted	DIN8039
		Hammer type tempered body sandblasted	
		Special tip for steel &Granite	
		Extra Long Length	
Milled		Black & white tempered body	DIN8039
		Nickle plated double flute	
		Special tip	

MASONRY DRILL

► MASONRY DRILL Q/32181 RFD004(0)

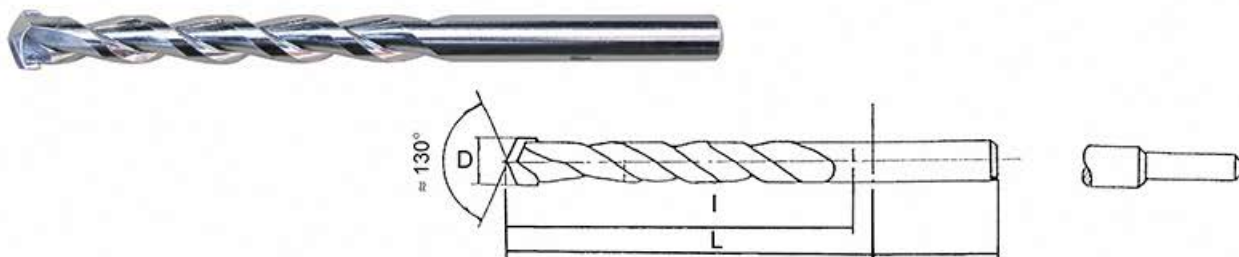

DRILLING TOOLS

DRILLING TOOLS

Diameter		Short Series		Long Series		Expanding Length (For drilling wall)					
Size (mm)	+T14 +T12 (mm)	L (mm)	≈ l (mm)	L (mm)	≈ l (mm)	L (mm)	≈ l (mm)	L (mm)	≈ l (mm)		
3.0	+0.25 +0.10	60	35								
4.0	+0.30 +0.12	75	39								
4.5											
5.0											
5.5					150	85					
6.0											
6.5	+0.36 +0.15	100	54								
7.0											
8.0											
8.5											
9.0		120	80	200	135						
10.0											
11.0	+0.43 +0.18	150	90								
12.0				220	150						
13.0											
14.0											
16.0											
18.0						400	350	600	550		
20.0	+0.52 +0.21	160	100								
22.0											
24.0											
25.0											

MASONRY DRILL SET

DRILLING TOOLS

DRILLING TOOLS

M501



Size(mm):4, 5, 6, 8, 10mm

M502



Size(mm):4, 5, 6, 8, 10mm

M503



Size(mm):4, 5, 6, 8, 10mm

M504



Size(mm):4, 5, 6, 7, 8mm

M701



Size(mm):4, 5, 6, 7, 8, 10, 12mm

M801



Size(mm):3, 4, 5, 6, 7, 8, 9, 10mm

MASONRY DRILL SET

DRILLING TOOLS

DRILLING TOOLS

M802



Size(mm):3, 4, 5, 6, 7, 8, 9, 10mm

M803



Size(mm):3, 4, 5, 6, 7, 8, 9, 10mm

M804



Size(mm):3, 4, 5, 6, 7, 8, 9, 10mm

M301



Size(mm)	Length(mm)			
	200	300	400	600
8,10,12	200	300	400	600
10,12,14	200	300	400	600
12,14,16	200	300	400	600

M302



Size(mm):8, 10, 12 × 400mm

M801



Size(mm):6, 8, 10, 12, 13, 14 × 300mm

ELECTRIC HAMMER DRILLS



HAMMER DRILL

▶ ECS001 STANDARD FLUTE SDS SHANK HAMMER DRILLS

▶ ECS002 DOUBLE-FLUTES SDS SHANK HAMMER DRILLS

▶ ECS003 CARBIDE TIP DOUBLE-FLUTES SDS SHANK HAMMER DRILLS

DRILLING TOOLS

DRILLING TOOLS

Diameter	Length
4	110
4	160
5	110
5	160
5	210
6	110
6	160
6	210
6	310
8	110
8	160
8	210
8	260
8	450
10	110
10	160
10	210
10	260
10	310
10	350
10	400
10	450
12	160
12	210
12	350
12	400
12	450
12	800
12	1000
14	160
14	210
14	260
14	350
14	400
14	450
14	1000
16	210
16	350
16	450
16	600
16	800
16	1000
16	1200
22	260
22	350
22	450
22	600
22	800
22	1000
22	1200
25	260
25	800
25	1000
25	1200
28	600
28	800
28	1000
28	1200
30	600
30	800
30	1000
30	1200

Diameter	Length
4	110
4	160
5	110
5	160
5	210
6	110
6	160
6	210
6	310
8	110
8	160
8	210
8	260
8	450
10	110
10	160
10	210
10	260
10	310
10	350
10	400
10	450
12	160
12	210
12	350
12	400
12	450
12	800
12	1000
14	160
14	210
14	260
14	350
14	400
14	450
14	1000
16	210
16	350
16	450
16	600
16	800
16	1000
16	1200
22	200
22	350
22	450
22	600
22	800
22	1000
22	1200
25	200
25	800
25	1000
25	1200
28	600
28	800
28	1000
28	1200
30	600
30	800
30	1000
30	1200

Diameter	Length
4	110
4	160
5	110
5	160
5	210
6	110
6	160
6	210
6	310
8	110
8	160
8	210
8	260
8	450
10	110
10	160
10	210
10	260
10	310
10	350
10	400
10	450
12	160
12	210
12	350
12	400
12	450
12	800
12	1000
14	160
14	210
14	260
14	350
14	400
14	450
14	1000
16	210
16	350
16	450
16	600
16	800
16	1000
16	1200
22	260
22	350
22	450
22	600
22	800
22	1000
22	1200
25	260
25	800
25	1000
25	1200
28	600
28	800
28	1000
28	1200
30	600
30	800
30	1000
30	1200

HAMMER DRILL

ECS004 NEW CARBIDE TIP DOUBLE
-FLUTES SDS SHANK HAMMER DRILLS

ECS005 CROSS-HEAD DOUBLE -
FLUTES SDS SHANK HAMMER DRILLS

ECS006 THREE CUTTING EDGES THREE
FLUTES SDS SHANK HAMMER DRILLS

DRILLING TOOLS

Diameter	Length
4	110
4	160
5	110
5	160
5	210
6	110
6	160
6	210
6	310
8	110
8	160
8	210
8	260
8	450
10	110
10	160
10	210
10	260
10	310
10	350
10	400
10	450
12	160
12	210
12	350
12	400
12	450
12	800
12	1000
14	160
14	210
14	260
14	350
14	400
14	450
14	1000
16	210
16	350
16	450
16	600
16	800
16	1000
16	1200
22	260
22	350
22	450
22	600
22	800
22	1000
22	1200
25	260
25	800
25	1000
25	1200
28	600
28	800
28	1000
28	1200
30	600
30	800
30	1000
30	1200

Diameter	Length
5	110
5	160
5	210
6	110
6	160
6	210
6	310
8	110
8	160
8	210
8	260
8	450
10	110
10	160
10	210
10	260
10	310
10	350
10	400
10	450
12	160
12	210
12	350
12	400
12	450
12	800
12	1000
14	160
14	210
14	260
14	350
14	400
14	450
14	1000
16	210
16	350
16	450
16	600
16	800
16	1000
16	1200
20	210
20	1200
22	260
22	350
22	450
22	600
22	800
22	1000
22	1200
25	260
25	800
25	1000
25	1200
28	600
28	800
28	1000
28	1200
30	600
30	800
30	1000
30	1200

Diameter	Length
6	110
6	160
6	210
6	310
8	110
8	160
8	210
8	260
8	450
10	110
10	160
10	210
10	260
10	310
10	350
10	400
10	450
12	160
12	210
12	350
12	400
12	450
12	800
12	1000
14	160
14	210
14	260
14	350
14	400
14	450
14	1000
16	210
16	350
16	460
16	600
16	800
16	1000
16	1200
18	210
18	350
18	450
18	600
18	800
18	1000
18	1200
20	210
20	450
20	600
20	800
20	1000
20	1200
22	260
22	350
22	450
22	600
22	800
22	1000
22	1200
25	260
25	800
25	1000
25	1200

DRILLING TOOLS

HAMMER DRILL

▶ ECS007 CROSS-HEAD SDS MAX SHANK HAMMER DRILLS

▶ ECS008 SDS MAX SHANK HAMMER DRILLS

DRILLING TOOLS



Diameter	Length
10	280
12	280
14	280
16	280
16	400
16	505
18	280
18	400
18	505
20	400
20	505
22	400
22	505
22	600
25	400
25	505
25	600
28	505
28	600
30	505
30	600
32	505
32	600
35	505
35	600
38	505
38	600
40	505
40	600
42	505
42	600
42	800
42	1000



Diameter	Length
10	280
12	280
14	280
16	280
16	400
16	505
18	280
18	400
18	505
20	400
20	505
22	400
22	505
22	600
25	400
25	505
25	600
28	505
28	600
30	505
30	600
32	505
32	600
35	505
35	600
38	505
38	600
40	505
40	600
42	505
42	600
42	800
42	1000

DRILLING TOOLS

▶ ECS009 SDS PLUS SHANK HEXAGONAL BODY HAMMER DRILLS



Diameter	Length
5.8	160
5.8	210
6	160
6	210
6	260
6.5	160
6.5	210
6.5	260
7	160
7	210
7	260
7	310
7.5	160
7.5	210
7.5	260
7.5	310
8	160
8	210
8	260
8	310

ADAPTER FOR HAMMER DRILL

▶ PLUS SHANK FOR CHUCKS

▶ PLUS QUICK LOCK HOLDERS

DRILLING TOOLS

ECSC001



ECSC002



ECLH001 PLUS TO MAX



ECLH002 PLUS TO MAKITA



ECLH003 PLUS TO KANGO



DRILLING TOOLS

HAMMER DRILL

DRILLING TOOLS

DRILLING TOOLS



TRANSPARENT PLASTIC TUBE



PLASTIC TUBE



PLASTIC TUBE



PVC BAG



HALF SKIN CARD



SMALL HANGER



SMALL HANGER



BIG HANGER



BLISTER CARD

3PCS HAMMER DRILL SET



ECSDS001: 12 × 600(mm)
16 × 600(mm)
24 × 600(mm)

3PCS HAMMER DRILL SET

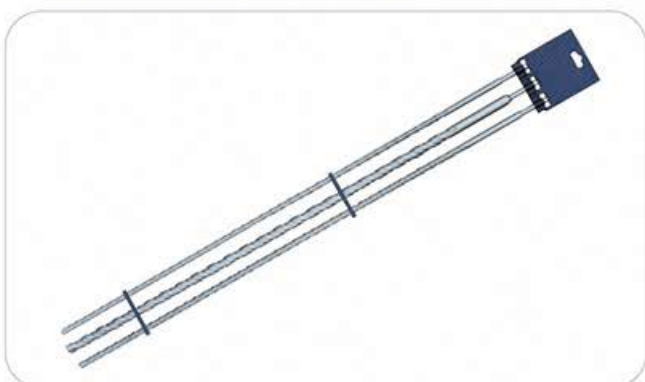

EFSDS002: 12 × 1000(mm)
16 × 1000(mm)
24 × 1000(mm)

5PCS HAMMER DRILL SET



EFSDS003: 12 × 450(mm)
14 × 450(mm)
16 × 450(mm)
18 × 450(mm)
22 × 450(mm)

5PCS HAMMER DRILL SET

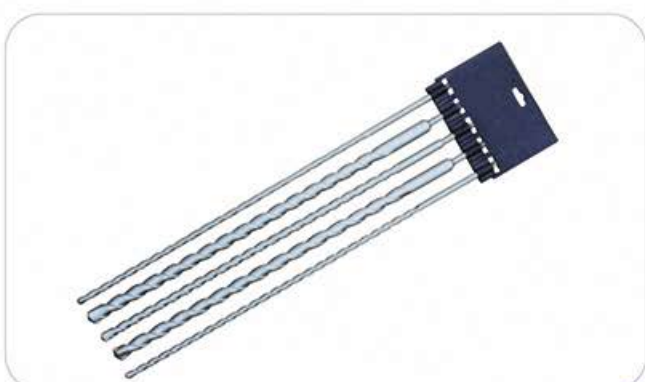

EFSDS004: 12 × 600(mm)
14 × 600(mm)
16 × 600(mm)
22 × 600(mm)
24 × 600(mm)

5PCS HAMMER DRILL SET



ECSDS005: 5 × 160(mm)
6 × 160(mm)
8 × 160(mm)
10 × 160(mm)
12 × 160(mm)

3PCS HAMMER DRILL SET



ECSDS006: 5 × 110mm 6 × 110mm 8 × 160mm

ECSDS007: 5 × 110mm 6 × 160mm 8 × 160mm

4PCS HAMMER DRILL SET



ECSDS008: 5,6,8,10 × 160mm

5PCS HAMMER DRILL SET



ECSDS009: 5,6,8,10,12 × 160mm

ECSDS010: 5,6,8 × 110mm
10,12, × 160mm

6PCS HAMMER DRILL SET



ECSDS011: 10,12,14,16,18,20 × 450mm

6PCS HAMMER DRILL SET



ECSDS012: 6,8,10 × 110mm
6,8,10 × 160mm

6PCS HAMMER DRILL SET



ECSDS013: 6,8,10 × 110mm
6,8,10 × 160mm

7PCS HAMMER DRILL SET



ECSDS014: 5,6,8 × 110mm
6,8,10,12 × 160mm

ECSDS015: 5,6,8 × 110mm
6,8,10,12 × 160mm

8PCS HAMMER DRILL SET



ECSDS016: 5,6,8,10 × 110mm
5,6,8,10 × 160mm

10PCS HAMMER DRILL SET



ECSDS017: 5,6,8 × 110mm
10,12 × 160mm
14,16 × 210mm
20 × 400mm
point chisel: 14 × 250mm
flat chisel: 14 × 250 × 40mm

11PCS HAMMER DRILL SET



ECSDS018: 5,6 × 110mm
6,8,10 × 150mm
10,12 × 210mm
10,12,16,20 × 450mm

11PCS HAMMER DRILL SET



ECSDS019: 5,6 × 110mm
6,8,10 × 150mm
10,12 × 210mm
10,12,16,20 × 450mm

12PCS HAMMER DRILL SET



ECSDS020: 5,6 × 110mm 8,10,12 × 160mm
 14 × 200mm 16 × 210mm
 18 × 300mm 20 × 450mm
 point chisel: 14 × 250mm
 flat chisel: 14 × 250 × 20mm
 groove chisel: 14 × 250mm

12PCS HAMMER DRILL SET



ECSDS021: 5,6 × 110mm 6,8,10 × 160mm
 10,12 × 210mm 10,12,16 × 450mm
 point chisel: 14 × 250mm
 flat chisel: 14 × 250 × 20mm

13PCS HAMMER DRILL SET



ECSDS022: 6,8,10 × 160mm
 8,10,12 × 210mm
 10,12,14 × 260mm
 point chisel: 14 × 250mm
 groove chisel: 14 × 250mm
 flat chisel: 14 × 250 × 20mm
 14 × 250 × 40mm

13PCS HAMMER DRILL SET



ECSDS023: 6,8,10 × 160mm
 8,10,12 × 210mm
 10,12,14 × 260mm
 point chisel: 14 × 250mm
 groove chisel: 14 × 250mm
 flat chisel: 14 × 250 × 20mm
 14 × 250 × 40mm

14PCS HAMMER DRILL SET



ECSDS024: 5 × 110mm/6,8,10 × 16mm
 8,10,12 × 210mm
 10,12,14 × 260mm
 point chisel: 14 × 250mm
 groove chisel: 14 × 250mm
 flat chisel: 14 × 250 × 20mm
 14 × 250 × 40mm

17PCS HAMMER DRILL SET



ECSDS025: 5,6,8,10 × 110mm/6,8,10 × 160mm
 8,10 × 210mm/12,14 × 260mm
 point chisel: 14 × 140mm
 14 × 250mm
 flat chisel: 14 × 140 × 20mm
 14 × 250 × 20mm
 14 × 250 × 40mm

17PCS HAMMER DRILL SET



ECSDS026: 5,6,8,10 × 110mm/6,8,8,10,10 × 160mm
 8,10,10,12 × 260mm
 point chisel: 14 × 140mm
 14 × 250mm
 flat chisel: 14 × 140 × 20mm
 14 × 250 × 20mm
 14 × 250 × 40mm

19PCS HAMMER DRILL SET



ECSDS027: 8,8,10,10 × 160mm
 10,12,13,14,16,16 × 210mm
 16,20,25 × 450mm
 point chisel: 14 × 250mm(3pcs)
 flat chisel: 14 × 250 × 20mm(3pcs)
 groove chisel: 14 × 250mm

19PCS HAMMER DRILL SET



ECSDS028: 5,5,5,6,6,5,7 × 160mm(2pcs)
 12,14,16 × 210mm
 10,18,25 × 450mm
 point chisel: 14 × 250mm
 plat chisel: 14 × 250mm × 20mm
 14 × 250mm × 40mm

20PCS HAMMER DRILL SET

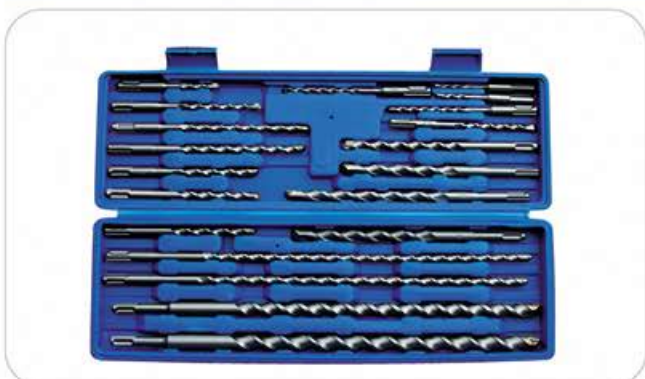

ECSDS029: 5,6,8 × 110mm
 6,8,8,10,10,12 × 160mm
 8,10,12,14 × 210mm
 14,16 × 260mm
 10,12,16,20 × 450mm

37PCS HAMMER DRILL SET



ECSDS030: 6,8,10 × 160mm(3pcs)
 8,10,12 × 210mm(3pcs)
 8,10,12,14 × 260mm(3pcs)
 10,12,14 × 310mm
 point chisel: 14 × 250mm
 groove chisel: 14 × 250mm
 flat chisel: 14 × 250 × 20mm
 14 × 250 × 20mm

50PCS HAMMER DRILL SET



ECSDS031: 5 × 110mm(10pcs)
 6 × 110mm(10pcs)
 6 × 160mm(5pcs)
 8 × 160mm(5pcs)
 10 × 160mm(5pcs)
 8 × 210mm(5pcs)
 10 × 210mm(5pcs)
 12 × 210mm(5pcs)

SDS CHISEL

DRILLING TOOLS

DRILLING TOOLS



The chisel can be used with electric hammer and it is widely applicable and high efficient chiselling hole, cutting, chiselling groove tool for concrete and brick wall. Our products include bull point, small flat chisel, big flat chisel, gouge and groove chisel. The chisel length can be made according to customers' requirements. The shank type can be selected according to below list of shank structure.

EC001



SIZE: 14*250mm 17*250mm

EC002



SIZE: 14*250*20mm 17*250*22mm

EC003



SIZE: 14*250*40mm

EC004



SIZE: 18*300mm 18*400mm 18*600mm

EC005



SIZE: 18*300*25mm 18*400*25mm 18*600*25mm

EC006



SIZE: 18*300*50mm 18*400*50mm 18*600*50mm

EC007



SIZE: 18*300mm 18*400mm 18*600mm

EC008



SIZE: 18*300*50mm 18*400*50mm

EC009



SIZE: 17*280mm 17*450mm 21*320mm 21*450mm

EC010



SIZE: 17*280*22mm 17*450*22mm 21*320*26mm 21*450*26mm

EC011



SIZE: 17*280*50mm 17*450*50mm
21*320*50mm 21*450*50mm 17*280*75mm

EC012



SIZE: 17*280mm

EC013

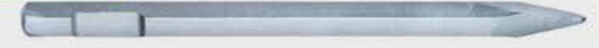

SIZE: 19*300mm 19*400mm 19*600mm

EC014



SIZE: 19*300*25mm 19*400*25mm

EC015



SIZE: 21*320mm 21*450mm

EC016



SIZE: 21*320*26mm 21*450*26mm

SDS CHISEL SET

DRILLING TOOLS

DRILLING TOOLS

EC017



SIZE:19*400mm

EC018

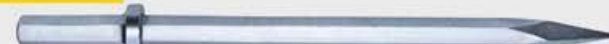

SIZE:19*330mm 19*400mm 19*500mm 22*45mm
25*500mm 28*550mm 32*550mm

EC019



SIZE:17*280mm

EC020



EC021

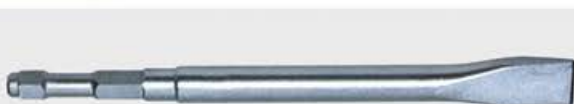

SIZE:18*270*22mm

EC022



SIZE:30*410mm

EC023



SIZE:30*410*35mm

EC024



SIZE:28*400*35mm 28*500*35mm

EC025



SIZE:22*380mm

EC026



SIZE:23.9*350mm

EC027

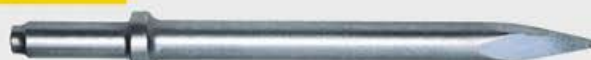

EC028



SIZE:28*450mm

EC029



SIZE:19*300*80mm

EC030



SIZE:19*300*125mm

ECCS031



ECCS032



ECCS033

